

SmarT-Bay 6-Light T5HO



ORDERING INFORMATION

Catalog Number: Example: SBW654EB4-4JP

SB	W	6	54	EB	4	4	JP
FIXTURE	BODY WIDTH	LAMPS	WATTAGE	BALLAST SOURCE	BALLAST QUANTITY	VOLTAGE	OPTIONS
SB-SmarT-Bay Series Industrials	W-Wide (6 Light)	6	54-54W T5HO	EB-Electronic ballast	4-(1) 2-light ballast and (1) 4-light ballast	1-120V 2-208V 3-240V 4-277V 5-480 6-120/277V (voltage sensing)	See Page 4

LAMP SPECIFICATIONS

- (6) Philips #29083-3 F54T5/841/HO/ALTO 4,100K, 5,000 initial lumens

ELECTRICAL SPECIFICATIONS

- T5HO 6-light
2-lamp #ICN-2S54-90C
4-lamp #ICN-4S54-90C-2LS
- 120v, 277v, 480v, 120-277v
- Advance Centium ballast family

SENSOR SPECIFICATIONS

- Circular 30-40 ft. diameter coverage.
- Passive infrared
- 120/277v or 208v/240v/480v operating voltage
- Mounting height 15 to 45 ft.
- Time delay: see Sensor Section
- Green LED indicator
- UL and cUL Listed

PRODUCT SPECIFICATIONS

- Precision die-formed steel housing
- Architectural white post painted finish eliminates exposed edges for safe handling
- Beveled Miro 4 highly specular anodized aluminum reflector
- Accepts stem, pendant, or chain mounting
- Outperforms conventional 400 watt MH technology for a fraction of the energy consumption
- Standard with electronic ballasts
- Instant-on
- Low profile
- Multi-level switching capability
- Top access plate
- Pre-wired for all-on/all-off
- 3-year system warranty
- UL 1598 Listed for damp locations
- Individually packaged on skid (standard)
- Available in environmentally friendly Job-Pack for reduced waste (see option JP)

TECHNICAL INFORMATION

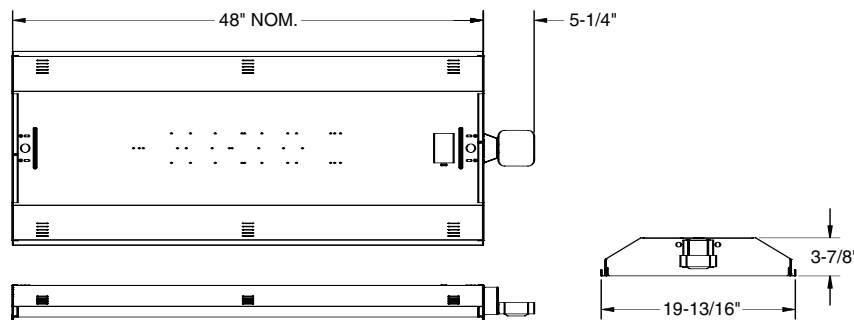

UL Damp Location Listed.
UL File Number: E137651

SENSOR SPECIFICATIONS

KEY SPECS

- Lens: High Bay 360°
- Enclosure: Fixture Mount Box
- Power Type: Line Voltage
- Detection: Passive Infrared (PIR)

TYPICAL APPLICATIONS

- High Mounting (15-45 ft.)
- Individual Fixture Control
- T5HO Fluorescent

FEATURES

- LampMaximizer™ Control
- Minimum On Timer
- Up to 45 ft. Mounting
- Self-Contained Relay, no Power Pack Required
- No Minimum Load
- Push-Button Programmable
- Switch Counter (in 1000s)
- Total Lamp On Time (in hrs)
- % Lamp Life Used Indicator
- End of Lamp Life Warning
- Green LED Indicator

PHYSICAL SPECS

- Size: 3.63" H x 3.63" W x 1.50" D (9.22 cm x 9.22 cm x 3.81 cm)
- Weight: 6 oz.
- Mounting: 1/2" knockout
- Color: White

ELECTRICAL SPECS

- Load Rating (1 Phase Only)
- 800 W @ 120 VAC
- 1200 W @ 277 VAC
- Motor Load 1/4 HP
- Frequency 50/60 Hz
- Timers are 1.2x for 50 Hz

ENVIRONMENTAL SPECS

- Operating Temp 14° to 160° F (-10° to 71° C)
- Storage Temp -14° to 160° F (-26° to 71° C)
- Relative Humidity 20 to 90% non-condensing

OTHER

- UL and CUL Listed
- 5-Year Warranty
- Made in the U.S.A.



The LampMaximizer™ sensor from Sensor Switch allows users to aggressively target energy savings while still protecting lamp life. This is done via the patent pending LampMaximizer™ control algorithm that determines the sensor switching behavior to maximize both lamp life and energy savings. Standard sensors only control the amount of time that the fixture remains on after occupancy was last detected, making simultaneous pursuit of maximum lamp life and energy savings impossible.

SENSOR OPERATION

The sensor detects changes in the infrared energy given off by occupants as they move within the field-of-view. When occupancy is detected, a self-contained relay switches the lighting on. This starts the sensor's minimum on timer countdown. Set to 15 minutes for T5 ballasts and 30 minutes for T8 ballasts, the minimum on timer prevents short cycling of lamps.

The sensor also uses a second occupancy time delay that determines how long after occupancy was last detected that the lights will turn off. This delay is very different than traditional sensor time delays in that it is continuously calculated by the LampMaximizer™ algorithm and then dynamically adjusted up or down relative to the observed usage of the space in which it is installed. This allows a shorter more energy saving time delay to be utilized if it won't adversely affect lamp life, thus maximizing energy savings. In practice, the lights will only turn off if both the minimum on and occupancy sensor time delays have been met.

The sensor is powered by and can switch line voltage. The LampMaximizer™ works equally well in high-activity areas as well as those of limited use. While the occupancy time delay is constantly being modified by the LampMaximizer™, the user can choose the initial, maximum, and minimum times for it via the push-button. Additional information stored in the sensor and available to a user includes: number of switches, total lamp time on, and the percentage of life remaining for a lamp. Finally, the sensor LED will blink constantly for 31 days once 70% of the projected lamp life has been reached.

Minimum On Requirement met due to LampMaximizer™

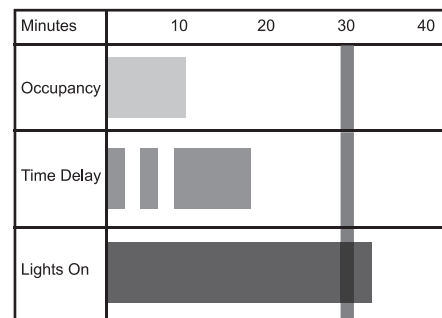

Minimum On Time

Minimum On Requirement met due to Occupancy

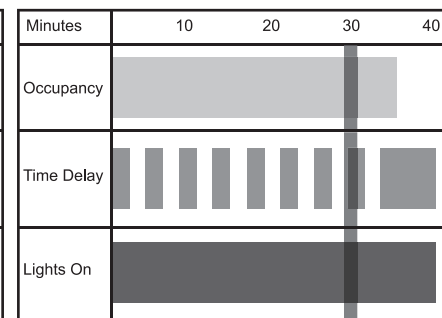

Minimum On Time



SENSOR SPECIFICATIONS

COVERAGE PATTERN

High Bay 360° View Lens

- Best choice for 15 to 45 ft. mounting heights
- 15 to 20 ft. radial coverage overlaps area lit by a typical high bay fixture
- Large Motion (e.g. walking) detection up to a 35 ft. mounting height
- Extra Large Motion (e.g. forklifts) detection up to a 45 ft. mounting height

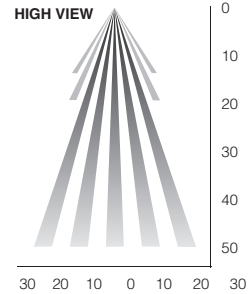
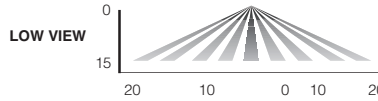

End of Aisle



Center of Aisle

MASKING KIT

- A masking kit is provided in order to mask off a portion of the view pattern for end-of-aisle applications; or to trim the sensor's side viewing to create a rectangular pattern for center-of-aisle viewing only.

Note: Heat producing sources controlled by the sensor must not be in the view pattern of the sensor. If sensor cycles or appears to continually stay "On", move sensor or mask lens segments that view the source.

WIRING (DO NOT WIRE HOT)

Standard Wiring
 BLACK* - Line Input
 BLACK* - Load Output
 WHITE - Neutral

INITIAL POWER UP (3 MINUTE WARM-UP)

The relay in the sensor is shipped in a latched closed position so that when power is initially applied the lights will come on. The sensor will then begin to time out after a 1-3 minute warm-up period. If the lights do not immediately turn on (initial installation only) the latching relay opened during shipment and will close after warm-up period is over.

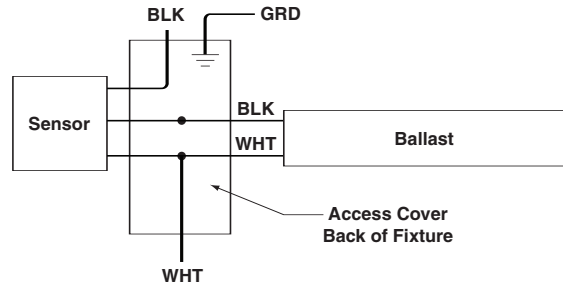

4-27

Smart-Bay 6-Light T5HO

PHOTOMETRICS

Lamp Type: **F54T5/841/HO/ALTO**
 Initial Lumens: **4400**
 # of Lamps: **6**

Characteristics

Total Rated Lamp Lumens	26400 (6 lamps)
Total Luminaire Efficiency	86.2 %
CIE Type	Direct
Spacing Criteria (0-180)	1.24
Spacing Criteria (90-270)	1.10
Spacing Criteria (Diagonal)	1.24
Basic Luminous Shape	Rectangular w/Sides
Luminous Length (0-180)	4.00 ft
Luminous Width (90-270)	1.55 ft
Luminous Height	0.00 ft

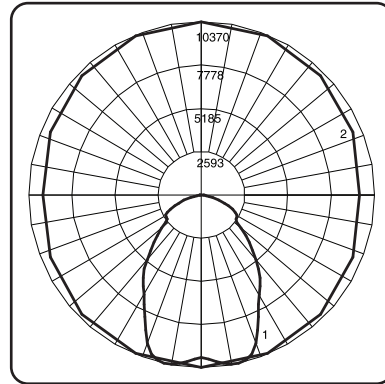

Lumen Summary

Zone	Lumens	%Lamp	%Fixture	Zone	Lumens	%Lamp	%Fixture
0-30	7835.27	29.7	34.4	90-120	0.	0.	0.
0-40	12258.58	46.4	53.9	90-130	0.	0.	0.
0-60	19362.13	73.3	85.1	90-150	0.	0.	0.
0-90	22755.64	86.2	100	90-180	0.	0.	0.
Total Luminaire =				0-180	22755.64	86.2	100.0

IES Spacing Criteria: End = 1.24 Diagonal = 1.24 Cross = 1.10

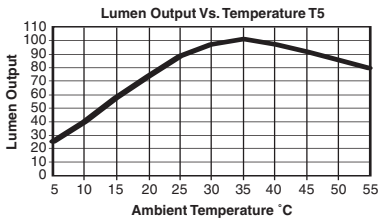

These tests were performed according to standard IESNA procedures. A specific ballast and lamp combination was used. Other lamp and ballast combinations may yield different results. This test was conducted in a controlled laboratory environment where the ambient temperature was held at 25°C.

Field performance may differ in regards to change in luminous output as a result of differences in ambient temperature and mounting method.

The above chart is a temperature profile of T5 lamps. It graphs light output versus ambient temperature. It may be helpful in determining the feasibility of using a T5 lighting system.

OPTIONS

- 6/2** 6 lights on; 2 lights off
- 6/4** 6 lights on; 4 lights off
- F1** Fusing for 120/277v - specify voltage
- 6C** 6-foot black S/O cord
- 6F** 6-foot black S/O cord and 15A NEMA plug
- 6T** 6-foot black S/O cord and 20A NEMA plug
- E1** 1 lamp EM powerpack (700 lumen T5)
- E2** 1 lamp EM powerpack (1250 lumen T5)
- JP** Job-Pack environmentally friendly pack (18 qty.)

Consult factory for additional lamp color temperature.
 Cable mount up to 10 feet.

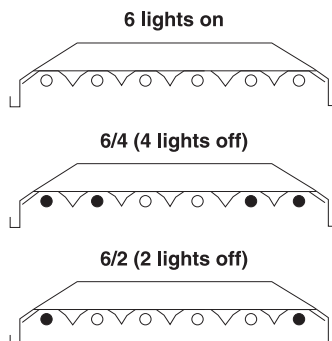

ACCESSORIES

- TSCHAIN** QuickHang with Jack Chain
- TSWLENS** Wide Lens
- TSWGUARD** Wide Wire Guard
- TSWGYM** Wire Guard with prismatic high-impact acrylic lens, wide body
- TSWGYM-C** Wire Guard with clear acrylic lens, wide body

SMART-BAY EXTENDED WARRANTY

**PHILIPS
ONE SOURCE
ONE SOLUTION
ONE WARRANTY**

SMART-BAY WARRANTY STATEMENT

THE SMART-BAY IS THE ONLY MOTION SENSORED LINEAR FLUORESCENT HIGHBAY THAT CARRIES A COMPLETE SYSTEM WARRANTY ON ALL COMPONENTS INCLUDING LAMPS, BALLAST, SENSOR AND LUMINAIRE... ONE COMPANY...ONE SYSTEM...ONE WARRANTY. ALL OTHER T5HO/T8 HIGHBAY LUMINAIRE MANUFACTURERS WILL WARRANTY THEIR PRODUCT FOR A PERIOD OF TIME BUT NO LAMP MANUFACTURER WILL PROVIDE THEIR STANDARD WARRANTY FOR T8 OR T5HO LAMPS WHEN USED WITH A MOTION SENSOR DUE TO RAPID DETERIORATION OF THE LAMP DUE TO FREQUENT CYCLING.

THE SMART-BAY SYSTEM CARRIES A 36 MONTH WARRANTY. THE COMPLETE SYSTEM WARRANTY COVERS DEFECTS IN MATERIAL AND WORKMANSHIP. PROPERLY INSTALLED PRODUCT THAT WE DETERMINE TO BE DEFECTIVE WILL BE REPAIRED OR REPLACED AT OUR DISCRETION. THIS WARRANTY COVERS THE FIXTURE, LAMP, BALLAST, SENSOR AND ANY OTHER COMPONENT INSTALLED ON THE PRODUCT BY THE FACTORY. THE WARRANTY COVERS THE REPAIR OR REPLACEMENT OF THE PRODUCT AND DOES NOT EXTEND TO TRANSPORTATION, INSTALLATION OR REPLACEMENT CHARGES. NO OTHER WARRANTY, EITHER EXPRESSED OR IMPLIED, BEYOND THIS STATEMENT IS INCLUDED.

ANY FIELD MODIFICATIONS TO THE SMART-BAY VOIDS THE PRODUCT WARRANTY

WARRANTY CLAIMS CAN BE HANDLED BY CALLING 1-800-372-3331 OR BY LOGGING ON:
www.advancetransformer.com/RETURN